

图面类型 内部发行文件

MARK	DATE	DESCRIPTION	DESIGN
A	2021.03.26	新版发行	HJY

组装线缆后的连接器尺寸

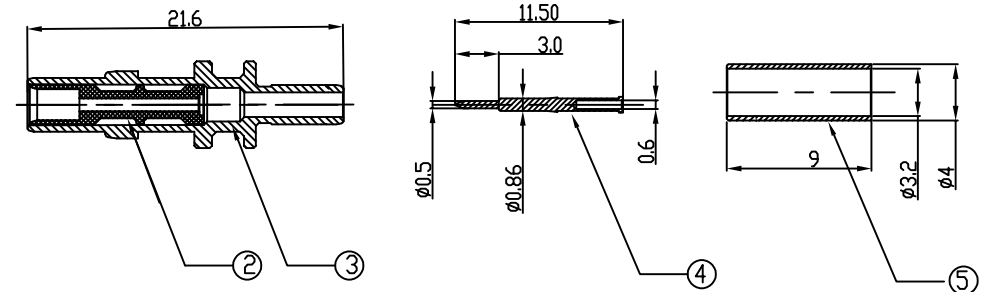
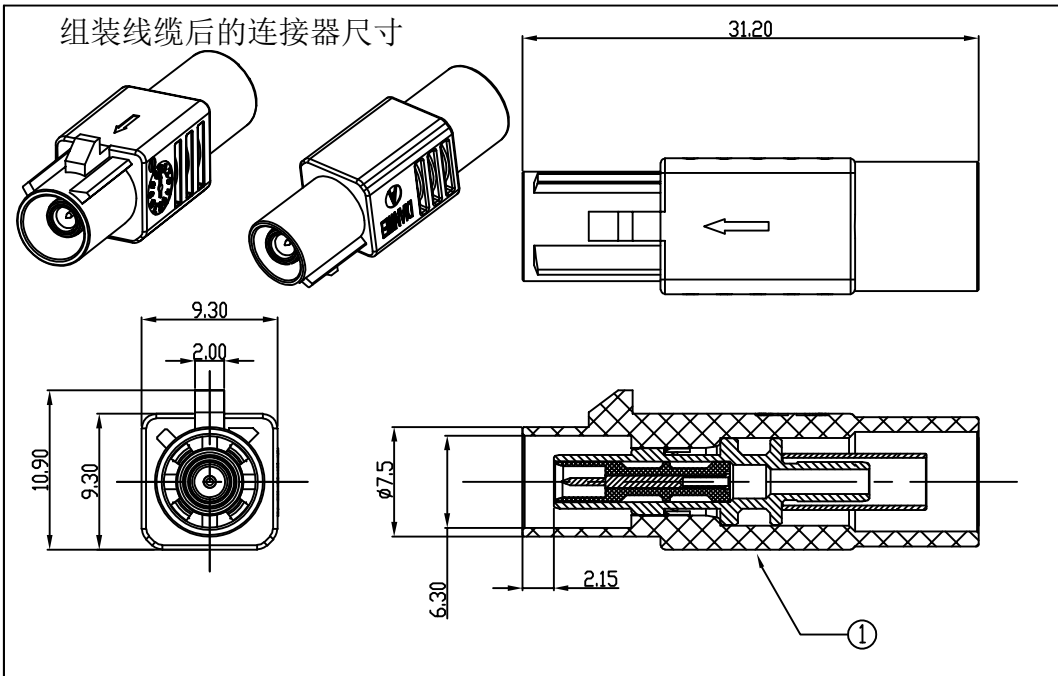

技术要求

- 1.1: 接触阻抗: 50mOHM Max,
- 1.2: 频率范围: DC to 6GHz驻波比: 0-6GHz 1.58Max
- 1.3 额定电压: 60V/DC. 额定电流: 1A/PIN.
- 1.4: 绝缘电阻: 1000MOHM Min.
- 2.1: 插拔次数: 25 TIMES Min.
- 3.1: 工作温度: -40℃~+105℃
- 4.1: 除零件2和零件3组装在一起外, 其它零件单包.

序号	名称	零件料号	材质	数量	表面处理
⑤	线夹	7.03J3.000780	COPPER ALLOY	1	Ni
④	插针	7.03J3.000270	COPPER ALLOY	1	Au
③	主体	7.03J3.000770	COPPER ALLOY	1	Ni
②	绝缘体	7.03M3.001010	LCP	1	无
①	壳体	7.03M3.00123X	PA66	1	无

UNLESS OTHERWISE SPECIFIED TOLERANCE			
ANG	TOL	DIM	TOL
.X	±2.0°	.X	±0.30
.XX	±1.0°	.XX	±0.20
.XXX	±0.5°	.XXX	±0.10

DIANWEI 东莞市钿威电子科技有限公司





DONGGUAN DIANWEI ELECTRONIC TECHNOLOGY CO., LTD

Tel: +86-769-8788 8322 Fax: +86-769-8788 8321 E-mail: dianwei@188.com Http://www.dianwei.cn

	DRAWING NO	PART NAME:	非防水FAKRA连接器 (M)				
	C-7.03A3	PART NO.	7.03A3.00101X				
APPROVED	VERIFIED	DESIGN	DATE	UNITS	SCALE	PAGE	REV
		CHEN	2021.03.26	mm	1:1	1/2	A

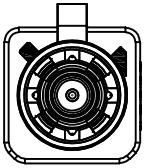
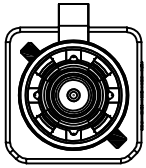
图面类型 内部发行文件

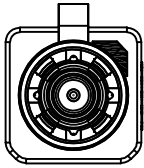
MARK	DATE	DESCRIPTION	DESIGN
A	2021.03.26	新版发行	HJY

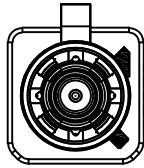
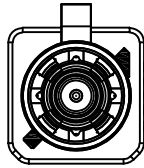
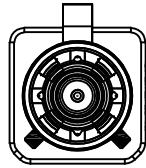
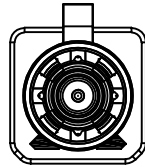
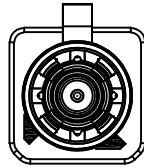
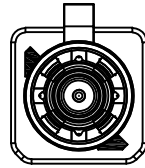
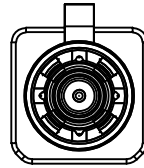

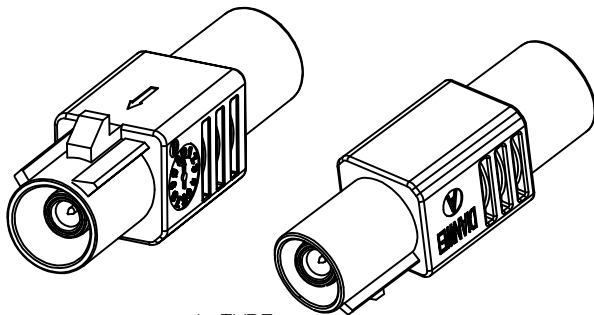
						
7.03A3.001010 A TYPE (Black 黑色9005)	7.03A3.001011 B TYPE (White 白色9001)	7.03A3.001012 C TYPE (Blue 蓝色5005)	7.03A3.001013 D TYPE Bordeaux 枣红色/4004	7.03A3.001014 E TYPE Green 绿色/6002	7.03A3.001015 F TYPE Brown 棕色/8011	7.03A3.001016 G TYPE Grey 灰色/7031
						
7.03A3.001017 H TYPE Violet 紫罗兰/4003	7.03A3.001018 I TYPE Beige 米黄色/1001	7.03A3.001019 K TYPE Curry 咖喱色/1027	7.03A3.00101A L TYPE Camine Red 深红/3002	7.03A3.00101B M TYPE Pastel Orange 粉橙色/2003	7.03A3.00101C N TYPE Pastel Green 粉绿色/6019	7.03A3.00101D Z TYPE Water Blue 水蓝色/5021



A TYPE
立体示意图

NOTE: ALL RIGHTS RESERVED, BANNED COPY!

UNLESS OTHERWISE SPECIFIED TOLERANCE			
ANG	TOL	DIM	TOL
.X	±2.0°	.X	±0.30
.XX	±1.0°	.XX	±0.20
.XXX	±0.5°	.XXX	±0.10

 		东莞市钿威电子科技有限公司 DONGGUAN DIANWEI ELECTRONIC TECHNOLOGY CO., LTD Tel: +86-769-8788 8322 Fax: +86-769-8788 8321 E-mail: dianwei@188.com Http://www.dianwei.cn					
		DRAWING NO	PART NAME:	非防水FAKRA连接器 (M)			
APPROVED	VERIFIED	C-7.03A3	PART NO.	7.03A3.00101X			
		DESIGN	DATE	UNITS	SCALE	PAGE	REV
		CHEN	2021.03.26	mm	1:1	2/2	A