

DRAWING TYPE

CUSTOMER DRAWING

MARK	DATE	DESCRIPTION	DESIGN
F	2016.04.16	ADD PERFORMANCE	WANGPENG
G	2017.06.12	Change Plating Note	CHEN
H	2020.05.06	UPDATE DRAWING	CHEN

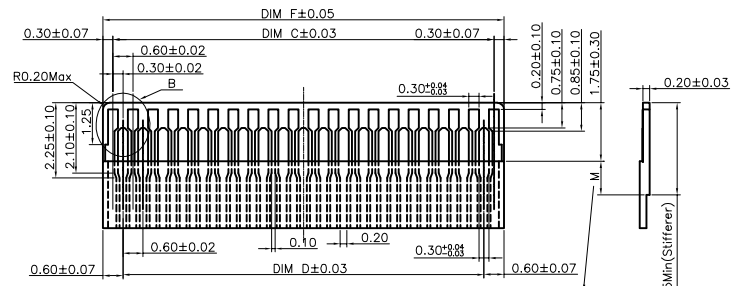
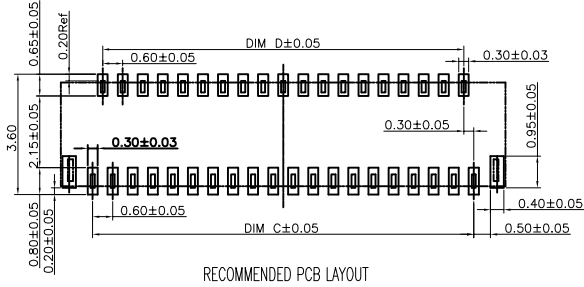
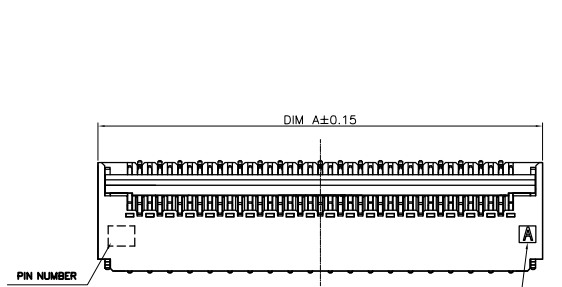

Dimension M must be 0.5mm minimum when the stiffener than 2.75mm

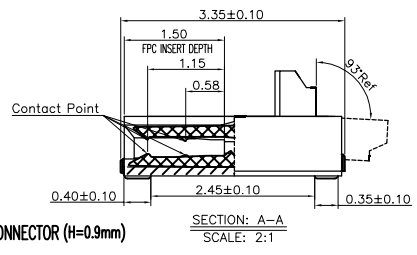
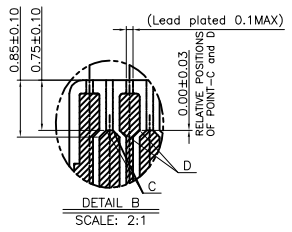
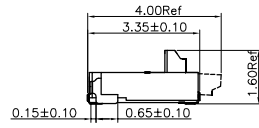
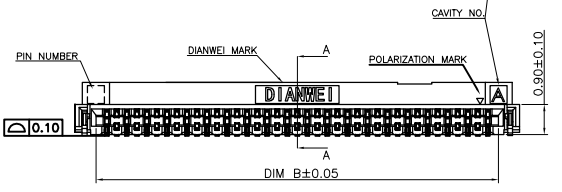

Pin No.	P/N	DIM A	DIM B	DIM C	DIM D	DIM E	DIM F
9	8.03A0.009200	4.30	3.03	2.40	1.80	3.73	3.00
11	8.03A0.011200	4.90	3.63	3.00	2.40	4.33	3.60
13	8.03A0.013200	5.50	4.23	3.60	3.00	4.93	4.20
15	8.03A0.015200	6.10	4.83	4.20	3.60	5.53	4.80
17	8.03A0.017200	6.70	5.43	4.80	4.20	6.13	5.40
19	8.03A0.019200	7.30	6.03	5.40	4.80	6.73	6.00
21	8.03A0.021200	7.90	6.63	6.00	5.40	7.33	6.60
23	8.03A0.023200	8.50	7.23	6.60	6.00	7.93	7.20
25	8.03A0.025200	9.10	7.83	7.20	6.60	8.53	7.80
27	8.03A0.027200	9.70	8.43	7.80	7.20	9.13	8.40
31	8.03A0.031200	10.90	9.63	9.00	8.40	10.33	9.60
33	8.03A0.033200	11.50	10.23	9.60	9.00	10.93	10.20
35	8.03A0.035200	12.10	10.83	10.20	9.60	11.53	10.80
37		12.70	11.43	10.80	10.20	12.13	11.40
39	8.03A0.039200	13.30	12.03	11.40	10.80	12.73	12.00
41	8.03A0.041200	13.90	12.63	12.00	11.40	13.33	12.60
45	8.03A0.045200	15.10	13.83	13.20	12.60	14.53	13.80
49		16.30	15.03	14.40	13.80	15.73	15.00
51	8.03A0.051200	16.90	15.63	15.00	14.40	16.33	15.60
57	8.03A0.057200	18.70	17.43	16.80	16.20	18.13	17.40
61	8.03A0.061200	19.90	18.63	18.00	17.40	19.33	18.60

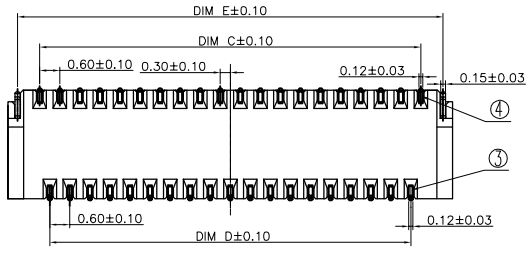

- FPC NOT MATING CONDITION BANNED CLOSURE
- PART NO. LEGEND:
8.03A0.***200
① ② ③ ④ ⑤
- SERIES NAME: 8.03A0=0.3MM FFC/FPC DUAL CONTACT SIDE CONNECTOR (H=0.9mm)
- CONTACT PIN NUMBER: ***=CONTACT PIN NUMBER
- CONTACT AREA PLATING SPEC: GOLD PLATING: 2=1~3u"; 3=5u"; 4=10u"; 5=15u"
- SOLDER AREA PLATING SPEC: GOLD PLATING: 2=1~3u"; 3=5u"; 4=10u"; 5=15u"
- UNSPECIFIED: 0=NONSENSE
- UNSPECIFIED: 0=NONSENSE

- PERFORMANCE:
- CURRENT RATING: 0.2A/PIN.
- VOLTAGE RATING: 30V (AC/DC).
- CONTACT RESISTANCE: INITIAL VALUE 100mOHM Max.
- INSULATION RESISTANCE: 50MOHM Min.
- DIELECTRIC WITHSTANDING VOLTAGE: 100V AC FOR 1MINUTE;
- DURABILITY: 20 TIMES Min.
- OPERATING TEMPERATURE: -40°C~+85°C
- OPERATING HUMIDITY RANGE: 20% TO 85%

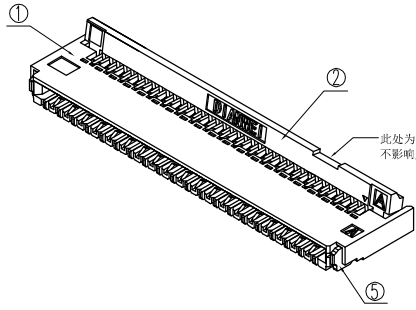

NOTE: ALL RIGHTS RESERVED, BANNED COPY!

UNLESS OTHERWISE SPECIFIED TOLERANCE			
ANG	TOL	DIM	TOL
.X	±3.0°	.X	±0.20
.XX	±2.0°	.XX	±0.10
.XXX	±1.0°	.XXX	±0.05

DIANWEI

东莞市钿威电子科技有限公司

DONGGUAN DIANWEI ELECTRONIC TECHNOLOGY CO., LTD

Tel: +86-769-8788 8322 Fax: +86-769-8788 8321 E-mail: dianwei@188.com Http://www.dianwei.cn

DRAWING NO	8.03A0-C	PART NAME	0.3mm FFC/FPC DUAL CONTACT SIDE CONNECTOR (H=0.9mm)				
APPROVED	VERIFIED	DESIGN	DATE	UNITS	SCALE	PAGE	REV
		CHEN	2020.05.06	mm	1:1	1/1	H

NO.	COMPONENTS	MATERIALS	FINISH/COLOR	SPECIFICATION	QUANTITY
5	STATOR	PHOSPHOR BRONZE			2
4	TERMINAL II	PHOSPHOR BRONZE			POSITIONS
3	TERMINAL I	PHOSPHOR BRONZE			POSITIONS
2	COVER	THERMOPLASTIC UL94V-0	BLACK		1
1	HOUSING	THERMOPLASTIC UL94V-0	NATURAL		1